

TRIPLET



INSTRUCTION MANUAL

MODEL 3413-A

TUBE TESTER

MANUAL ONLY - \$.75

Table of Contents

	Page
Tube Characteristics and Testing	4
Operating Instructions	5
Setting Controls and Value Test	5
Short Test	5
Tubes With Internal Pins Connected	6
Open Element Test	6
Filament and Tap Continuity Test	6
Pilot Lamp Testing	7
Ballast Tubes Continuity Test	7
Testing Multi-Purpose Tubes	7
Special Notes Appearing on Roll Chart	8
Picture Tube Adapter	10
General Notes	11
Tube Suffix Letter Symbols	11
Instructions for Making Chart Listings	12
Maintenance	13
Parts Location	13
Replaceable Parts	14
Wiring Diagram	15
Warranty	16

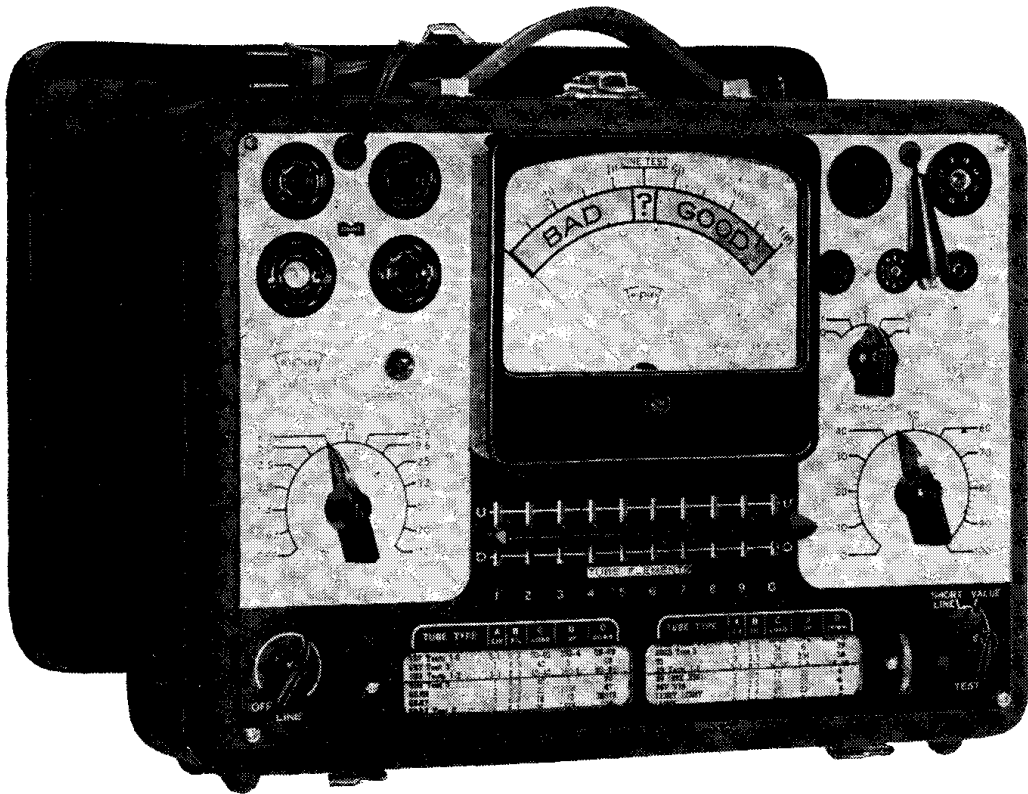

Model 3413A

Faster More Accurate Tube Testing

IMPROVED LEVER SWITCHING for complete control of each tube element. Gets at each tube pin to make an open and short check.

TUBES TESTED—Receiving tubes, gaseous rectifiers, resistor and ballast tube continuity and pilot lamps. Separate plate tests on rectifiers and diode types. The continuity test circuit may be used to check electrical appliances for shorts or open circuits.

GREATER METER SENSITIVITY for the new type tubes with low cathode current.

SHORT TEST—Shows slightest inter-element short or leakage while the cathodes are hot. Wide-angle neon indicator for greater visibility of the glow test.

TV PICTURE TUBE TESTS by means of the new BV adapter, without removing the tube from the receiver.

LINE VOLTAGE INDICATOR—Permits observation and adjustment for line fluctuations thereby insuring greater test accuracy. Line Voltage can be checked at any time by throwing snap-action switch for indication on the meter.

ILLUMINATED SPEED-ROLL CHART with test settings for over 700 tubes at the flick of a finger.

FILAMENT VOLTAGES (Full Range)—0.63 to 110 volts in 14 steps.

SHORT TEST for each element by a simple flip of the switch.

BIG 6-INCH METER, direct reading "BAD-?-GOOD" dial. Long-scale Model 626 adjusted to 500 Microamperes, 100 M.V. Exclusive RED ● DOT Life-time guaranteed against defects in workmanship or materials.

PANEL—Easy to read, red, black and white markings.

POWER SUPPLY—115 Volts, 50-60 cycle, A. C.

WEIGHT—20 pounds.

Tube Characteristics and Testing

The high stage of development of the radio tube art with its many variety of tubes has presented a definite problem to the technician in tube testing. In addition, the types of circuits and functions required of these tubes are continually changing. Previously, the common receiver consisted of amplifier tubes, an RF oscillator tube, mixer tube and detector tube. With improvements in AM and the advent of FM & TV, receiving tubes are required to perform additional functions as limiters, multivibrators, sweep oscillators, triggering action and other special functions. To accomplish some of these functions, the tube must be subjected to unusual operating conditions. In addition, differences between receivers impose a still wider range of conditions, as experienced by those who find a tube works in one set but not another.

The technician then is faced with the problem of procuring a universal tube testing device which will provide reasonable assurance the tube will operate satisfactorily under the conditions imposed. Obviously he cannot purchase a tester to test for each condition under which the tube will be subjected.

Fortunately, however, there is one thing common to all these tubes upon which performance depends, thus determining if the tube will operate under either normal or abnormal conditions. This is the condition of the cathode and its ability to supply electrons required for the space current. This does not mean that all tube characteristics are measured by the cathode emission, but it does form a good basis to judge tube performance under normal and abnormal conditions.

Your Model 3413-A employs the cathode condition test in a practical easy to read Good — Bad scale. In addition, the mechanical condition of the tube is easily tested, such as open elements, shorted elements, and leakage between elements. The Model 3413-A, in one compact package providing a universal tube testing device for tubes which must operate under a wide variety of conditions, is the easiest to operate.

The ever increasing variety of tubes for AM, FM, TV has established the need for complete flexibility in tube testers as made possible by the unique lever switch originated by Triplet.

This test combined with the facility to set up new tubes through the flexible Triplet lever switching and the ability to test the mechanical condition of the tube (open elements, shorted elements, leakage) in one compact package makes this a most practical and universal tube tester.

Operating Instructions

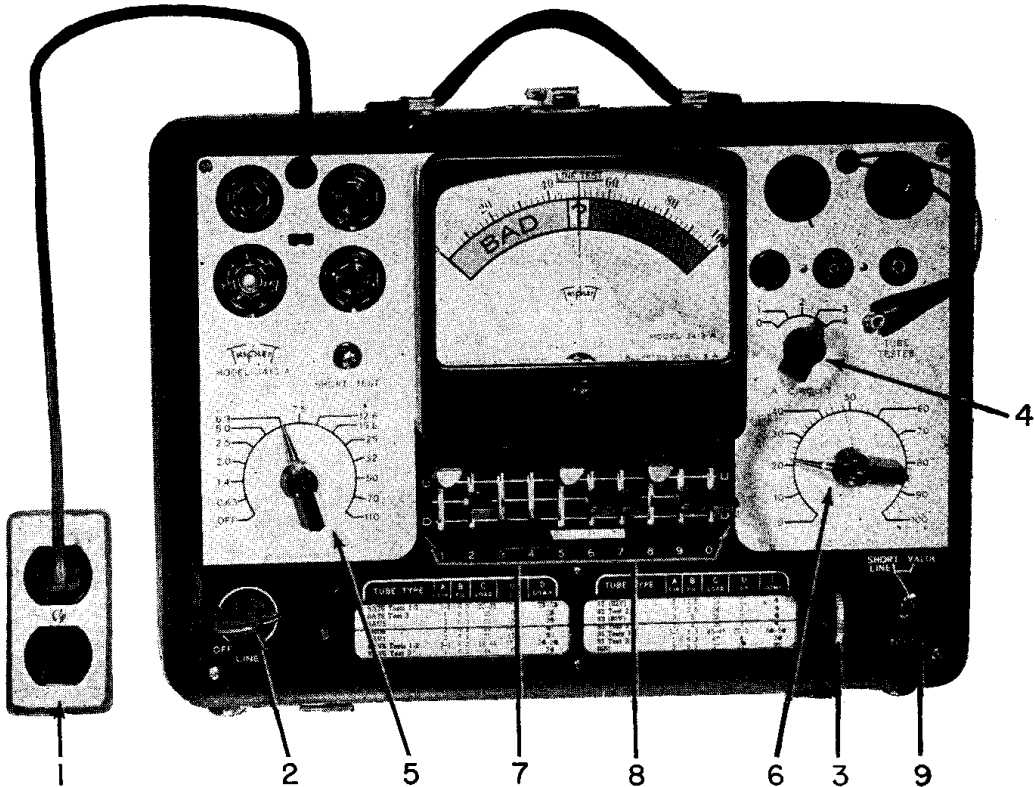

SETTING CONTROLS

1. Insert power cord into a 110 volt AC 60 cycle outlet.
2. Turn "LINE" control clockwise until pointer of meter rests over "line Test" mark.
3. Set roll chart to type tube to be tested.

Example

Type Tube	A CIR.	B FIL.	C LOAD	U UP	D DOWN
6AU5	3	6.3	22	158	37

4. Set "A Circuit" switch to position number 3.
 5. Set "B Filament" switch according to chart 6.3.
 6. Set "C Load" to position 22 as shown.
 7. Levers 1, 5 & 8 should be placed in the up position.
 8. Levers 3 and 7 should be placed in the down position.
Levers not listed in either column must be left in the center position.
- NOW insert tube in tester socket. After tube has had sufficient time to heat up check line voltage setting again. If necessary then reset control No. 2 so meter pointer reads at "LINE TEST" mark.
9. To test tube hold control No. 9 in "Value" position and read meter.

SHORT TEST

With all controls set according to the roll chart, one at a time, move each lever to the opposite position and return, this applies only to settings in light face type. If pin corresponding to lever number is shorted to an-

other pin or element the neon lamp "SHORT TEST" will have a bright red glow.

The above should be carried out on all levers listed in the light face type. Levers in the center position are not used for this type tube.

TUBES WITH INTERNAL PINS CONNECTED

LEVERS IN "UP" POSITION

All tubes which have internal connections, (as noted by dark face type in "Up" position) should be checked by moving these levers to the down position simultaneously. These elements should not indicate a short if this procedure is used.

LEVERS IN "DOWN" POSITION

The following tubes with dark face type levers in the "down" position should be checked by moving all levers listed below to the "Up" position simultaneously. These elements should not indicate short if this procedure is followed.

2E26	pins	1-4-6		1204	pins	4-6-8
6AK5	"	2-7		5636	"	2-8
6AN5	"	2-7		5651	"	2-7
6BC5	"	2-7		5654	"	2-7
6BE7	"	3-8		5662	"	2-5
6BV7	"	7-9		5686	"	1-3-8
6N4	"	2-6		5840	"	2-4-8
7B6	"	4-7		5899	"	2-4-8
7E6	"	4-7		5905	"	2-4-8
7W7	"	4-7		5908	"	2-8
				6028	"	2-7
12BY7	"	3-9		6146	"	1-4-6
12SG7	"	3-5		6169	"	4-5
12SH7	"	3-5		9001	"	2-7
14B6	"	4-7		9002	"	2-7
14E6	"	4-7		9003	"	2-7
14W7	"	4-7		9006	"	2-7
713A	"	3-5				
717A	"	3-5				
2729	"	2-7				

OPEN ELEMENT TEST

Set all controls and levers according to the roll chart for tube under test. With "TEST" knob control No. 9 in "Value" position, one at a time move each lever which is in the up position shown in light face type to the down position and return to correct setting. Continuity between tube pins or elements being tested is indicated by a change in pointer deflection. A small change denotes a satisfactory plate or screen connection. A large change will indicate a satisfactory grid connection. When there is only one lever in up position, no open element test need be made.

FILAMENT AND TAP CONTINUITY TEST

* Asterisk shown after tube type.

Set all controls and levers according to the roll chart EXCEPT "B Filament" switch which must be set at 0.63 position for this test.

One at a time move each lever shown in DARK FACE type on chart to the opposite position and return to chart setting. For example, type 35W4 has 4 and 6 shown in dark face type down.

Move lever number 4 to the up position and return to down position. Then move lever number 6 to up position and return to down position. In testing continuity the "SHORT TEST" neon lamp will indicate "GOOD" by a bright red glow.

PILOT LAMP TESTING

(Pilot lamps and other miniature base lamps.)

- A With the line cord connected, set "LINE" control No. 2 so the meter pointer will read on "Line Test" mark.
- B Set control No. 5 "B Filament" to correct voltage of lamp to be tested.
- C Insert lamp in socket in center of large 7 prong socket.
- D A "GOOD" lamp is indicated by normal lighting of its filament.

BALLAST TUBE CONTINUITY TEST

With line cord connected set "LINE" control No. 2 so the meter pointer will read on "Line Test" mark.

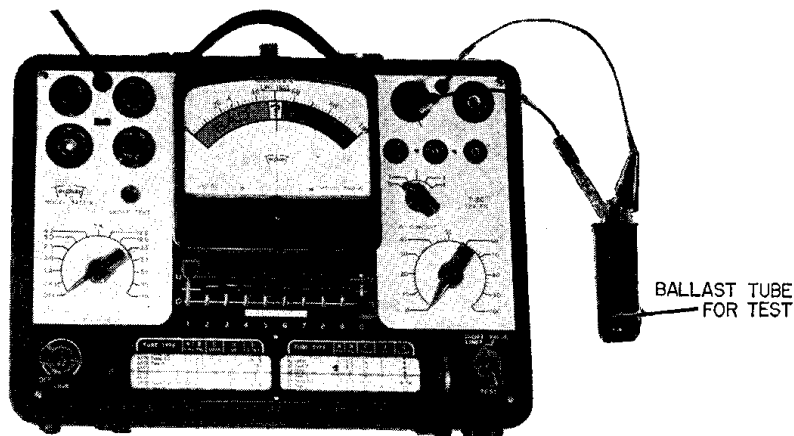

Set controls No. 2 "B Filament", No. 4 "A Circuit" and No. 6 "C Load" to 0 or off position. Lever number one up and lever number 0 down position. Connect a short jumper lead to pin one of the octal socket (Marked with a short line on panel). Short grid cap lead and jumper lead together and note that the neon lamp glows. Connect grid cap clip and jumper lead to pins of ballast tube or to terminals of appliance being tested. A bright glow of the neon lamp indicates continuity.

CAUTION: Do not handle the metal parts of the test lead during the test.

Refer to the ballast tube or appliance manufacturer's data for internal connections.

TESTING MULTI-PURPOSE TUBES

Some multi-purpose tubes require more than one test. An example is a type 6H6. Notice test information given on the roll chart for this type tube. "Tests 1-2" following the tube type means that two tests are necessary, and that all information for making these two tests is found in

the same line on the roll chart. A dash is used to separate information used in "Test 1" from information used in "Test 2." Using test information for a type 6H6 in the following example, all information not used in "Test 1" is ignored.

Chart Reads:	A	B	C	U	D
6H6 Tests 1-2	1-1	6.3	25-25	3-5	47-78
For Test 1 use:	1	6.3	25	3	47
For Test 2 use:	1	6.3	25	5	78

When information for two tests is given on a single line, this information is separated by a dash. Information for "Test 1" is found to the left of this dash, and information for "Test 2" is found to the right of this dash.

Notice that the "B-Filament" setting will always be the same though a tube may have one, two, three or more separate tests.

Refer to information given for a type 6SQ7. This tube requires three separate tests. Space permits giving information for only "Tests 1 and 2" on the first line. Information for "Test 3" is given on a second line.

SPECIAL NOTES APPEARING ON ROLL CHART

Special notes on the chart refer **only** to the type tube preceding the notation. For example, notice the note which follows a type 35B5. Also, notice the note which follows Test 2 for a type 117N7. This note applies only to Test 2 for this tube.

A note appearing on roll chart such as: "(Good=40)", etc., indicates that a reading of 40 or higher is satisfactory. (See type 2Y2 as an example. Another example is a type VR-75. A reading of 10 or better is satisfactory for this tube.)

Some tubes, such as VR-75 have more than one type designation. The preferred type number is given first, followed by the less common type number in parenthesis. In the case of a type VR-75, this tube is sometimes referred to as a type OA3 and is therefore listed as VR75 (OA3).

For information a cross reference listing of these tubes with two type numbers is given:

Tube Type	Listed Under	Tube Type	Listed Under
0A3	VR-75	CK568AX	CK5677
0B3	VR-90	CK569AX	CK5678
0C3	VR-105	CK605CX	CK5702
0D3	VR-150	CK608CX	CK5703
1F7GV	1F7	CK619CX	CK5744
4S	2S/4S	CK1006	1006/CK1006
6A4	6A4/LA	1201	7E5
6AB5	6N5	1203-A	7C4/1203A
6Q5	884	1232	7G7
6U5	6G5	1291	3B7
12B7	14A7	1294	1R4
12Z5	6Z5/12Z5	1299	3D6
25S	1B5	1642	2C21/1642
44	39	1852	6AC7
45Z5	40Z5	1853	6AB7
51	35	2051	2050
82V	82	2523NI	128A/2523NI
83V	83	5654	6BC5
84	6Z4	8016	1B3
G84	2Z2	A	866
V99	99V/V99	AS	57A
99X	99	ECL-80	6AB8
X99	99	EF-80	6BX6
117M7	117L7	G-2	2S/4S
123HY	113HY/123HY	G-84	2Z2
145HY	115HY/145HY	KR-1	1V
482-B	182-B	KR-5	6A4/LA
483	133	KR-25	2A5
485	484	KR-98	6Z4
GL-502-A	502-A/GL502-A	PL-83	15A6
585	50	V99	99V
879	2X2	XXB	3C6
951	1B4P	XXD	14AF7
CK556AX	CK5676	XXL	7A4

The letters "CL" appearing under Test 2 for tuning eye tubes indicate that the tuning eye shadow should be closed during this test (No meter reading will be observed). The letters "OP" under Test 3 for tuning eye tubes indicate that the eye shadow should be open during this test. (Tube type 6E5 is an example.)

A few special tubes have more than one top cap. A type 615HY is an example. When testing this tube, a wire jumper is connected between the two top caps, and the top cap test lead is clipped onto one of the tube's top caps.

Notes such as "(Adapt BR)" mean that a special adapter "BR" must be used in testing these tubes. Since these adapters are seldom, if ever, used in Radio and TV work, they are not included with your instrument. They may be obtained from your distributor on special order.

An asterisk (*) following a tube type indicates that filament and tap continuity test should be made for this tube.

For TV Picture Tube Tests—BV Adapter

With the BV adapter, Model 3413A will test every tube in a TV receiver INCLUDING the Picture Tube. A picture tube can be tested right in the shipping carton or in the receiver without removing the tube, as shown in the picture to the right. A time saver and safety factor

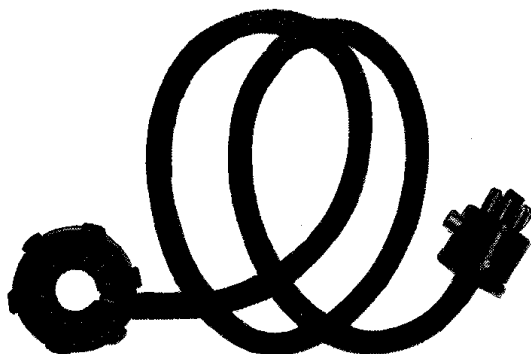

Service men with TV experience know that picture tube failures cause a low percentage of TV set failures. So why pay a high price for a unit that will test only CR and Picture Tubes when Triplet Model 3413-A and a BV adapter will test every tube in the TV receiver including the picture tube. With the BV adapter you are testing the spacing of elements and with the Electron Gun in operation reading cathode emission.

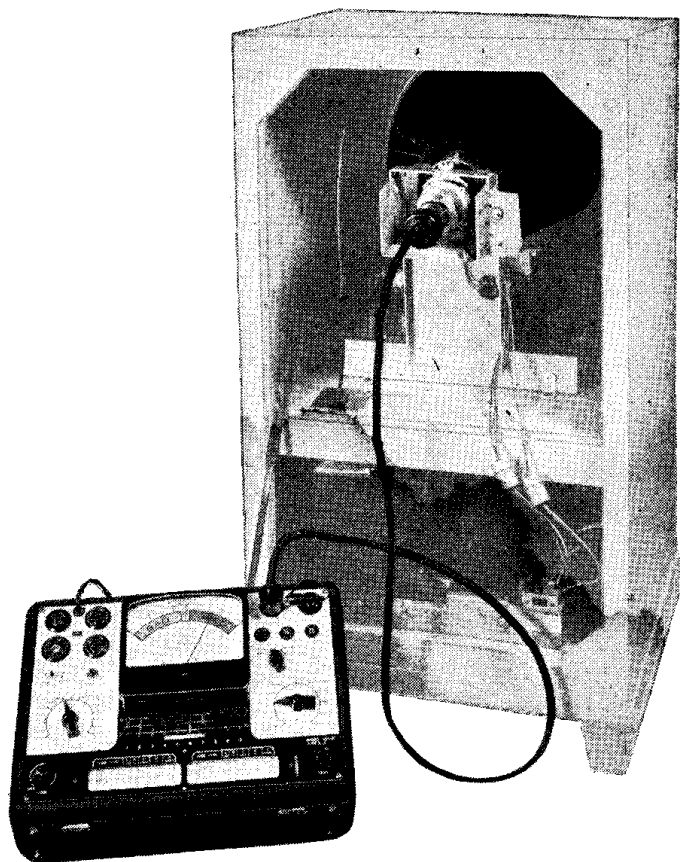

The same steps are used in testing TV picture tubes as any receiver type tube.

Supplied with each BV adapter is a data sheet for setting control and levers on the model 3413-A tester.

Picture tubes that have been in use for a year or two may test down in the Red or Bad but in many cases this means only the emission is below normal. Many picture tubes which show low emission will still operate but not as good as a tube with normal emission.

GENERAL NOTES

In order to keep the cost of your tube tester within reach of every serviceman, the special tube sockets for the acorn tube and the round sub-miniature have been left off your tester, since these types are not generally used. If you should find it necessary to check these types, adapters are available. (See Special Adapter Listing at bottom of page 13.)

Pointer indication above full scale indicates tube is extremely good or more than 130%. To make element continuity check on these tubes, turn lead control "C" so that pointer falls within end scale markings and proceed with continuity tests.

The jumper lead referred to in "CONTINUITY TEST" is not supplied with tester but may be obtained from your distributor on special order (Part No. T-2566-2, with clip T-79-29.)

The seven pin sub-miniature socket is used for 5, 6 and 7 prong tubes. Place the red dot on the tube to the extreme right to match the dot on the socket.

Cathode to heater leakage is indicated by a faint glow of the "SHORT TEST" neon lamp when making short test operation (8).

Lever markings 1 through 9 designate RMA tube pin numbers 1 through 9 respectively. Lever "O" designates the top cap connector.

TUBE SUFFIX LETTER SYMBOLS

In general, tubes with suffixes as noted below can be checked by using the set up for the tube without that suffix.

The letter G indicates a glass tube with an octal base.

GT Indicates use of a T-9 bulb. Y Indicates an "Intermediate loss" base.

The letters A, B, C, D, E, and F used in sequence indicate improved versions unilaterally interchangeable with the prototype or its subsequent versions.

W Indicates a military type and is assigned only on behalf of the armed forces.

CK are the prefix letters for some Raytheon subminiature tubes.

Instructions for Making Chart Listings

NEW TUBE TYPES

From time to time, supplementary tube data will be available to cover new tube types. Until this data is set up, the following may be used to obtain preliminary chart settings.

Use 3 or more new tubes and proceed as follows:

- (A) Refer to manufacturer's handbook under the particular tube type for filament voltage and pin connections.
- (B) Set "A-CIRCUIT" switch as follows:
 - "0" For tubes with cathode current below 1.5 Ma, generally subminiature types.
 - "1" for tubes with cathode current from 1 to 4 Ma, generally diode types.
 - "2" for tubes with cathode current from 3 to 15 Ma, generally filament types excluding diodes.
 - "3" for tubes with cathode current above 8 Ma, generally indirectly heated (cathode) types excluding diodes.
 - "4" for target or eye tubes, gaseous rectifiers and gaseous control tubes.
- (C) Set "B-FILAMENT" switch to filament voltage.
- (D) Refer to base drawing in "Manufacturer's Handbook" on tubes for the type being set up. Levers "1234, etc." compare to RMA pin numbers.
- (E) Set all levers in normal or center position. This is one of the "FILAMENT" positions and all elements in this position are tied together.
- (F) Find the first filament connection pin on tube base and leave corresponding lever in center position. This connects one side of filament to the filament transformer.
- (G) Find the second filament connection pin on tube base and move corresponding lever to "D" position. This connects the opposite side of the filament to the filament transformer. If filament is tapped at center, move corresponding filament pins to connect the two sections of filament in parallel. If filament has a panel lamp section, move the levers corresponding to this section to "D" position.
- (H) Find the cathode connection pin on tube base and move corresponding lever to "D" position. This connects the cathode to one side of the filament transformer.
- (I) If the tube is of the multi-section type such as duodiodes, duotriodes, etc., find the elements not under test and move corresponding levers to "D" position.
- (J) Move all levers corresponding to the other active elements under test to "U" position.
- (K) Insert tube into proper socket.
- (L) Turn on "LINE" control and adjust so that meter reads at "LINE TEST" mark.
- (M) Hold "TEST" switch in "VALUE" position. Adjust "C-LOAD" control for each tube so that the majority of the new tubes read 70 on the meter scale.
- (N) List settings in the book for further reference.

Parts Location

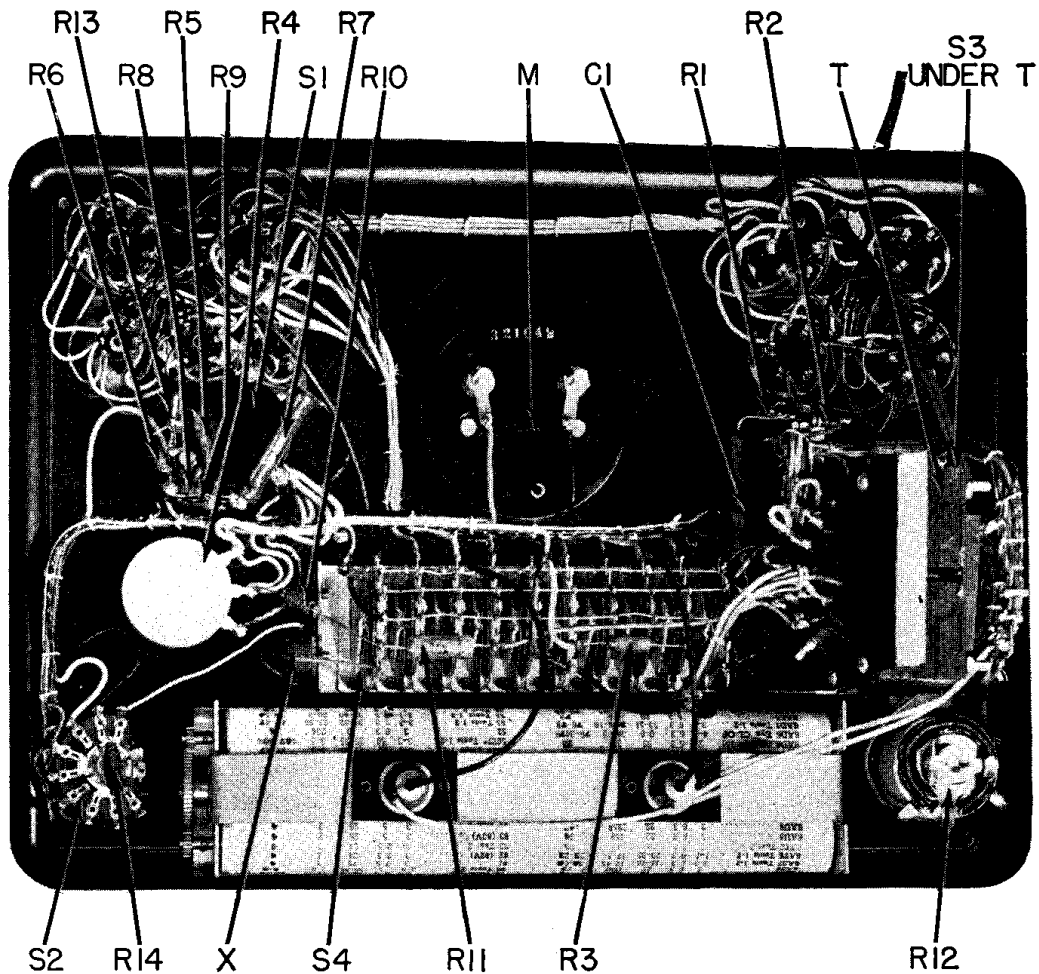

Maintenance

A Triplet 3413-A Tube Tester will require very little or no maintenance.

From time to time there will be a new roll chart to install. This will only be a few minutes work if you follow these instructions.

- A. Remove the four screws in the corners of the front panel. Remove back case.
- B. Lay tester face down on bench.
- C. Roll chart to the extreme end on top roller.
Remove tape holding chart to bottom roller.
Pull out old chart and remove tape from top roller.
- D. Thread new chart under bottom roller up to top roller and tape chart to roller. Take special care that the chart is taped straight on the roller. Roll chart on top roller very loosely. Now tape bottom of chart to the bottom roller. If the chart has not been rolled loosely on the rolls it will bind when rolled to the extreme ends.

The chart lamps sockets may be removed from the bracket to replace lamps.

Replaceable Parts 3413A

Ref. No.	Quan.	Part Name	Description	Triplet Part No.
C1	1	Capacitor	0.1 MFD 400 DC WV	T-2631-P27
R1	1	Resistor	100K ohm, ½W, ±10%	T-2601-½-100K
R2	1	Resistor	270K ohm, ½W, ±10%	T-15-1885
R3	1	Resistor	50 ohm, 1W, ±1%	T-15-1248
R4	1	Resistor	200 ohm, variable	T-16-7
R5	1	Resistor	450 ohm, 1W	T-15-1249
R6	1	Resistor	1800 ohm, 1 W	T-15-1251
R7	1	Resistor	2.5K ohm, 7W	T-15-2471
R8	1	Resistor	5K ohm, 1/2W, ±1%	T-15-1009
R9	1	Resistor	1K ohm, 1/2W, ±1%	T-15-1011
R10	1	Resistor	1.75K ohms, variable	T-15-62
R11	1	Resistor	68K ohm, ½W, ±1%	T-15-2487
R12	1	Resistor	175 ohm, variable, 25W	T-16-29
R13	1	Resistor	10K ohm, 1/2W, ±1%	T-15-1014
R14	1	Resistor	200 ohm, 1W	T-15-1858
S1	1	Switch	14 pos., 3 deck, 5 active pos	T-22A-177
S2	1	Switch	3 pole, double throw, 1 deck	T-22A-169
S3	1	Switch	20 pos., 1 deck, 15 active pos	T-22A-178
S4	1	Switch Assem	3 pos., lever, 10 decks	T-22-268
T	1	Transformer	110V, 19 sec. taps	T-23B-90
X	1	Rectifier	Copper oxide, 1/2 wave, 2 lead	T-2248-1
G	1	Lamp	Neon, 1/25W, GE	T-3024-2
M	1	Instrument	0-500 UA 100 Mv	T-52-661
	1	Case	Tester housing with hardware	T-10B-1014
	1	Cord	Line, 7 ft., black	T-2566-11-7
	10	Knob	Black, for element switches	T-34-37
	3	Knob	1 1/4" bar, black	5804
	2	Knob	2" bar, black	T-34-6
A1	1	Socket	7 prong, black	T-2455-171
	1	Socket	Bantam, 6 prong, black	T-2455-58
	1	Socket	9 prong, miniature, black	T-2455-92
	1	Socket	4 prong, black	T-2455-4
	1	Socket	5 prong, black	T-2455-5
	1	Socket	6 prong, black	T-2455-6
	1	Socket	Loctal, 8 hole black	T-2455-8L
	1	Socket	7 prong, miniature, black	T-2455-59
	1	Socket	Octal, 8 hole, black	T-2455-8
	1	Socket	5, 6, & 7 prong, subminiature	T-2455-80
ABOVE SERIAL 9036				

Special Adapters

ADAPTER	TUBE TYPE	PART NO.
BV	TV Picture Tubes	T-2247-BV
BR	Acorn Tubes	T-2247-BR
BW	Round Subminiature	T-2247-BW

Wiring Diagram, Model 3413-A

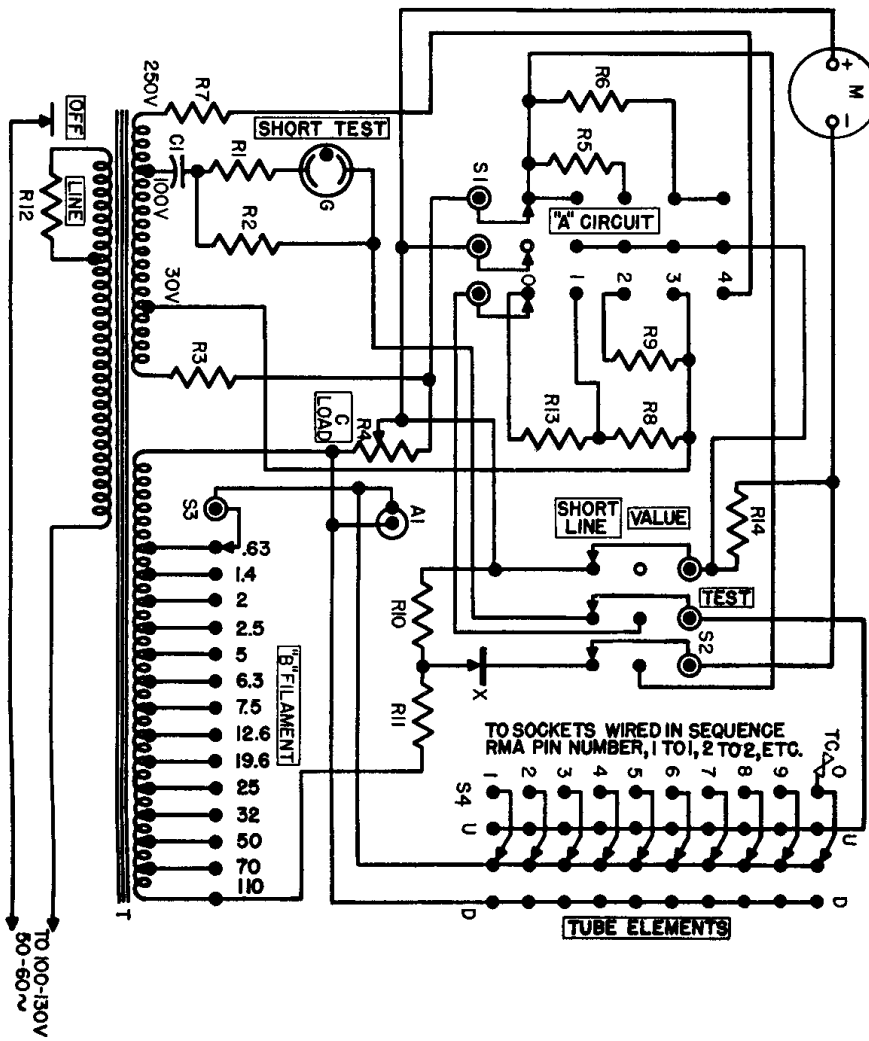

**WARRANTY FOR RADIO AND TELEVISION INSTRUMENT
AND TEST EQUIPMENT**

(Including Maintaining Parts of Discontinued Models)

**Adopted and Recommended by the Radio-Television Manufacturers
Association, 1951**

The Triplett Electrical Instrument Company warrants instruments manufactured by it to be free from defective material or factory workmanship and agrees to repair such instruments which under normal use and service, discloses the defect to be the fault of our manufacturing. Our obligation under this warranty is limited to repairing any instrument or test equipment which proves to be defective, when returned to us, transportation prepaid, within ninety (90) days from the date of original purchase and provided the serial number has been made known to us promptly for our records.

This warranty does not apply to any of our products which have been repaired or altered by unauthorized persons or service stations in any way so as, in our judgment, to injure their stability or reliability or which have been subject to misuse, negligence, or accident, or which have had the serial number altered, effaced, or removed. Neither does this warranty apply to any of our products which have been connected, installed, or adjusted otherwise than in accordance with the instructions furnished by us. Accessories including all vacuum tubes not of our manufacture used with this product are not covered by this warranty.

This warranty is in lieu of all other warranties expressed or implied and no representative or person is authorized to assume for us any other liability in connection with the sale of our products.

Parts will be made available for a minimum period of five (5) years after the manufacture of this equipment has been discontinued. Parts include all materials, charts, instructions, diagrams, accessories, et cetera, which have been furnished in the standard model.

RED-DOT LIFETIME GUARANTEE

The Red-Dot Lifetime Guarantee made only by Triplett warrants the meter to be free from defects in material and workmanship for the life of its original user.

The Triplett Electrical Instrument Co.

Manufacturers of
PRECISION MEASURING INSTRUMENTS
Bluffton, Ohio